

# Conditional Power Monitoring of Domestic Loads through Human Machine Interface

M.C. John Wiselin<sup>1</sup>, C.V. Aravind<sup>2</sup>, Rajparthiban Kumar<sup>3</sup> and Sugendran<sup>4</sup>

<sup>1</sup>Travancore Engineering College, India

<sup>2</sup>CIARG, Taylor's University, Malaysia

<sup>3</sup>The Nottingham University, Malaysia, <sup>4</sup>UCSI University, Malaysia

E-mail: aravindcv@ieee.org

(Received 12 August 2020; Accepted 20 September 2020; Available online 29 September 2020)

**Abstract** – A real time data acquisition system for load monitoring using human machine interface is presented. The design proposes a real time data acquisition whose parametric values are monitored and recorded for analysis purposes in a typical power system set-up. The parametric measurements includes the load voltage, load current, active power, reactive power, apparent power, power factor and line current. A perfect interface design is developed using graphical system design software. The recorded data is highly helpful in power monitoring and analysis for performance evaluation. The design gets complete with a manual supervisory control based on the data acquired through the interface module.

**Keywords:** Power Monitoring, DAQ, Graphical System Design

## I. INTRODUCTION

The essence of power has become the most dominant asset in human's life. Power distribution has made its premier role by contributing to applications from submicron level to all major devices [1]. A supervisory control is always the need of any power monitoring system which consists of a Remote Telemetry Unit (RTU), communication circuits and Human Machine Interface (HMI). The RTU includes the implementation of two different sensing devices which are the voltage transducer and a Hall Effect current transducer (LTS 15-NP). The voltage transducer is a self made sensor by using two rated resistors to match and calculate the reference voltage in order to transport the data into the data acquisition system. The general RTU established in the industries are attached with high current/voltage control relays, advanced

micro processing unit such as the Programmable Logic Controllers (PLC), capacitor banks and so forth. Advanced control systems are initially installed in the modern RTU's in order to provide better and efficient system operation. The communications involved in this system are basically wired transmission where only cables and wires are attached. USB communication are implemented for the Data Acquisition Module where data from the designed RTU are transmitted by wires and the processed information's are then passed to the host computer. The HMI design is basically built in order to view and display all the information's processed by the DAQ system from the RTU. LabVIEW software is used as the interface panel where the software is programmed in order to receive the correct data on the desired slots [2] [3].

## II. METHODOLOGY

The primary objective of this system is to monitor and control power in a single phase network. As mentioned, the system relies deeply on measurement and analysis on non-linear loads where the essence of active power, reactive power, load voltage, load current, apparent power, power factor and phase. The system is mounted on a wooden board with proper wiring and electrical grounding as well. Voltage transducer and the Hall Effect current transducer majors the initial design of the system and measurement is made on the hardware before the software measurement for validation of the results. Figure 1 shows the schematic representations of the design.

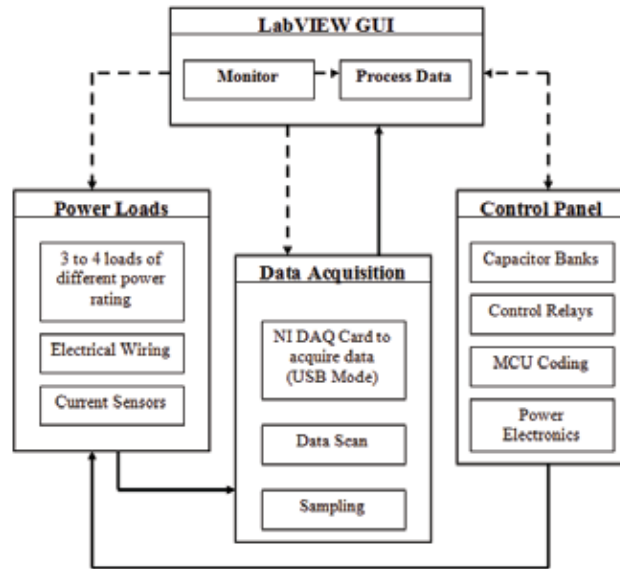

Fig. 1 Schematic Representation

The Data Acquisition Module is the heart of the system where this module holds the responsibility to perform signal and information acquisition. The National Instruments

6008 DAQ module is used and the mode of communication is established by using USB and the current transducer is from LEM as shown in Figure 2.

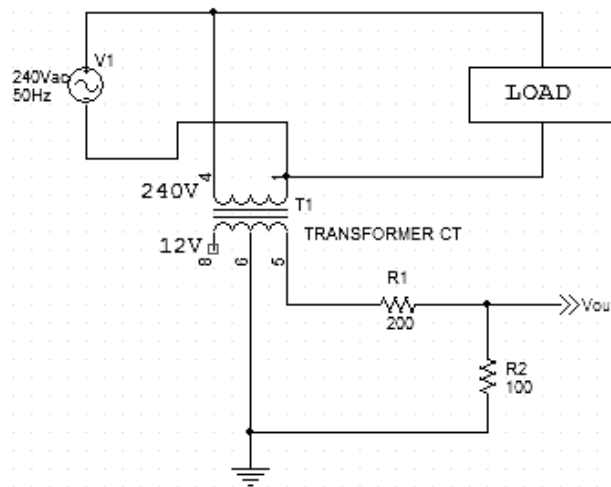

Fig. 2 Voltage transducer schematics

### III. SYSTEM DEVELOPMENT

The design of the hardware incorporated with the project is a rapid prototype where the materials are found correlating to the cost as well. Figure 3 shows the system module setup with the HMI interface panel.

Prioritized experimental loads as such the electric iron and electric kettle are tested as the loads manufactured with hot plates and coils draw very high current even

though these loads are for commercial use. The RTU is passed through the Hall Effect current transducer and it is connected to the switch wall sockets in order to sense the load current. The mathematics that involve in this section are applied to the current sensing methodology and the voltage transducer because the DAQ system can only take small value of voltage and current. Figure 4 shows the graphical system design interface for the system module under test. The design of the software caters the requirement of the

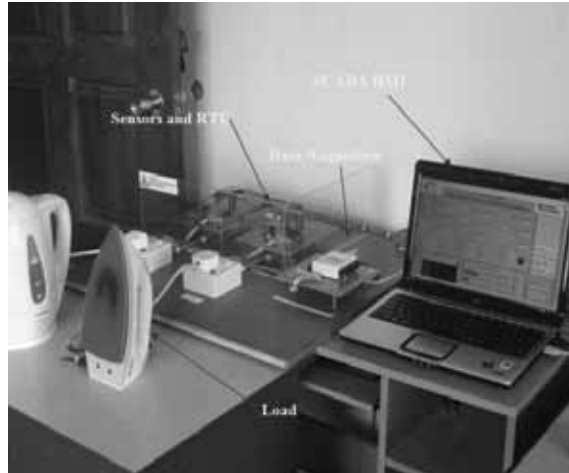

Fig. 3 System Module under test

power monitoring aspect where all the desired parameters are placed and analyzed. The most important part of the software is to visualize the RMS voltage and RMS current where the theoretical explanation of the control system can be mentioned. G-programming concept is used in this HMI

design with several important programming functions such as the indexing array, Boolean function, tab control and etc. The software design required a very long time in order to search and match the parameters in order to associate with the theoretical power equations. Figure 4 shows the software interface of the module.

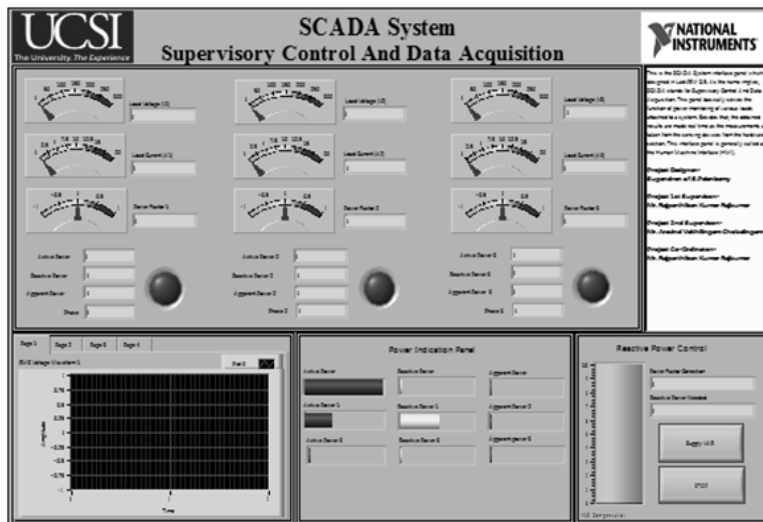

Fig. 4 Software interface panel

#### IV. TESTING AND RESULTS

In this design, the testing section is separated into two segments which are the hardware testing and the software testing. Figure 5 shows a typical test pane to acquire the data. As for the hardware section, the reference voltage and the scaling factor must be calculated manually before programming the software. Based on the measurement made, the reference voltage is observed to be 4.007 V and

the scaling factor calculated from the transformer ratio is about 60. The scaling factor is one of the most important components as this value determines the load voltage. On the other hand, the software testing is established by trial and error and thus, the current formulation is created manually. This is because any output that comes from the Hall Effect sensor is a voltage. Therefore, this situation be analyzed as voltage in terms of current by re-shuffling the formula as

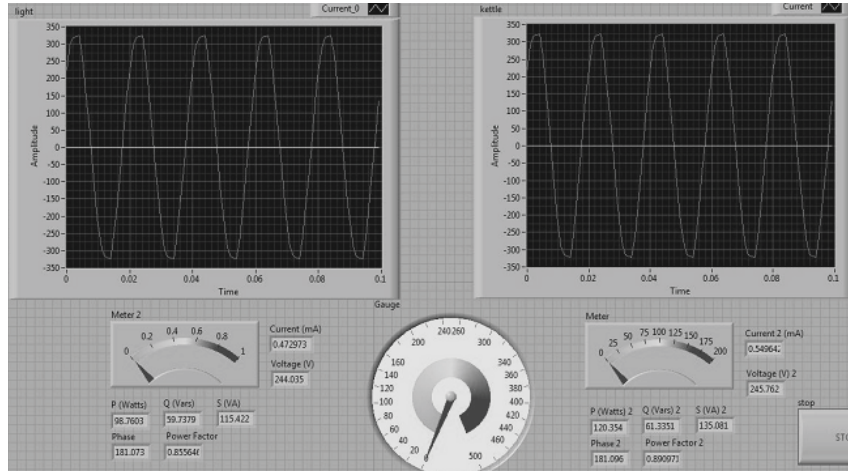

Fig. 5 Test Pane in the Graphical System Design

$$I_p = (X - 2.51) * 15 / 0.625;$$

Fig. 6 Sensed current formula

Figure 6 shows the equation representation of the sensed current formula. This formula indicates the sensed current on the load with a variable 'X' which is generated from the current sensor and the software performs calculation and finally displayed. The programs designed are not written but it is graphically programmed where with the functions are dragged and dropped as long as the function corresponding to the parameters are true. While loop condition is used as to measure real time signal acquisition and will continuously

loop until the user stops the simulation. The results were analyzed for a number of non-linear loads and are tabulated accordingly. A typical for the power monitoring over a certain period of time and the comparison in terms of the parametric identity are compared and presented in the Table I. Figure 7 shows the graphical module for the system result identification for more accurate understanding of the readings in terms of monitoring and for analysis purpose.

TABLE I PARAMETRIC RECORDS FOR DIFFERENT LOADS  
(SINGLE PHASE NON-LINEAR LOADS)

Loads	Load Voltage(V)	Load Current(I)	Apparent Power(S)	Active Power(W)	Reactive Power(Q)	Power Factor	Phase Measure
Electric Kettle	242.68	8.8682	2152.13	-2018.93	745.392	-0.938105	179.512
Laptop Supply	236.253	0.473294	111.817	-105.378	37.3984	-0.94241	179.509
Solder Gun	249.176	0.118228	29.4595	-25.7305	14.3458	-0.8734	179.552
Refrigerator	245.117	1.00926	247.386	-232.465	84.6181	-0.939682	179.511

Loads	Load Voltage(V)	Load Current(I)	Apparent Power(S)	Active Power(W)	Reactive Power(Q)	Power Factor	Phase Measure
Computer CPU	245.477	0.772348	189.594	-113.557	151.825	-0.598948	179.755
Desktop Monitor	244.07	0.374465	91.3957	-46.204	78.8566	-0.505538	179.834
Portable Fan	241.597	0.204274	49.3521	-45.7497	18.5089	-0.92701	179.578
Rice Cooker	249.571	3.51587	877.459	-850.06	217.557	-0.968775	179.494
Electric Iron	238.34	4.35936	1039.01	-972.957	364.551	-0.936427	179.513

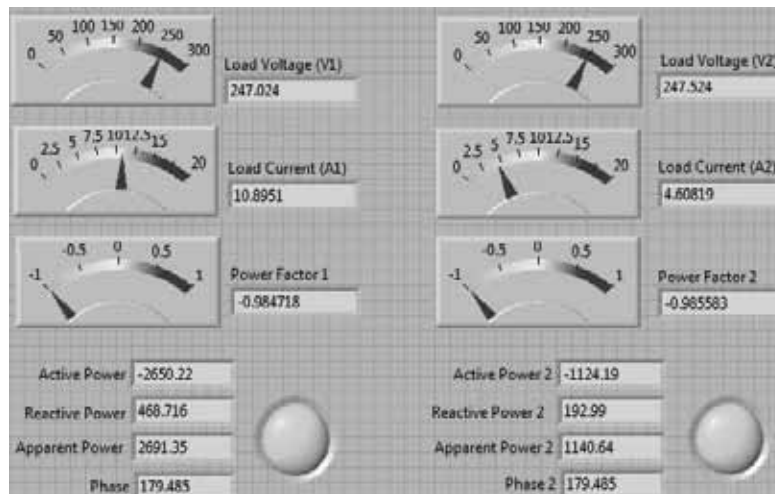

Fig. 7 System Result Identification

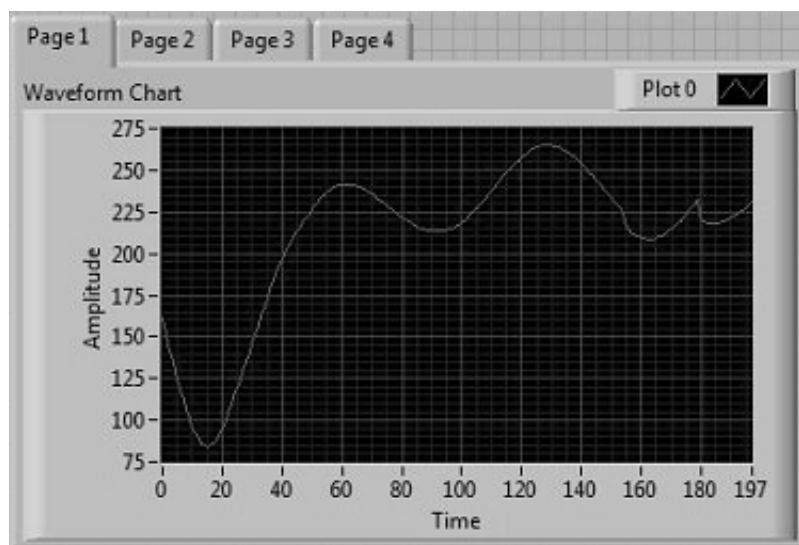

Fig. 8 RMS voltage waveform

## V. DISCUSSIONS

The results obtained using the system HMI interface is measured in real time sequence and fluctuations in the power line are observed. There are anonymous overshoots in the system which proves instability and erroneous in the power network. The average voltage reading measured manually from different switch wall sockets from the same residential house shows a reading of 247.2 V. Overvoltage occurrences would result to high inrush of currents towards the loads and damages are observed. From Table I, the active power and the power factor tend to provide the results in negative because the current direction is looping and reversed in polarity. But, the magnitude measure proves to be correct and the power factors of all residential loads are nearing unity. One of the sections in this project could not be implemented which is the control system aspect and voltage regulation. Even though experiments was conducted using self made capacitor banks and etc, the experiment fail to produce result and only the power monitoring was established for the time being. When the power monitoring was visualized in depth, a vast amount of information's was

obtained. Capacitor bank design and voltage regulation are best viewed in three phase networks and the precision of the involved measurement will increase. In this project, many problems were face in terms of measurement aspect when the formula node was incorrect, parameters measured wrongly and so forth. Some of the problems faced required lots of time and finally managed to obtain results and compared with the manufacturer ratings. The graphical essence was not depicted much as this only shows fluctuation for the RMS voltage and RMS current. Most measurements made are in numeric and the RMS voltage waveform is observed as shown in Figure 8.

## REFERENCES

- [1] Jens Matics, Gerhard Krost, Carsten Roggatz and Udo Spanel, "Dispersed Generation Modelling in SCADA Time Scale", *IEEE Publication*
- [2] D. Beck, H. Brand, S. Gotte, F. Herfuth, C. Rauth, R. Savreux, S. Schwarz, Y. Yazidjian, "The CS Framework- A LabVIEWBased Approach to SCADA System, 10<sup>th</sup> ICALEPCS Int. Conf. on Accelerator & Large Expt. Physics Control System. Geneva, 10 – 14 Oct 2005, 2005, pp.1051-60.
- [3] S. Sumathi, P. Surekha, "LabVIEW Based Advanced Instrumentation Systems", Springer Publication, 2007